

—PLAN—

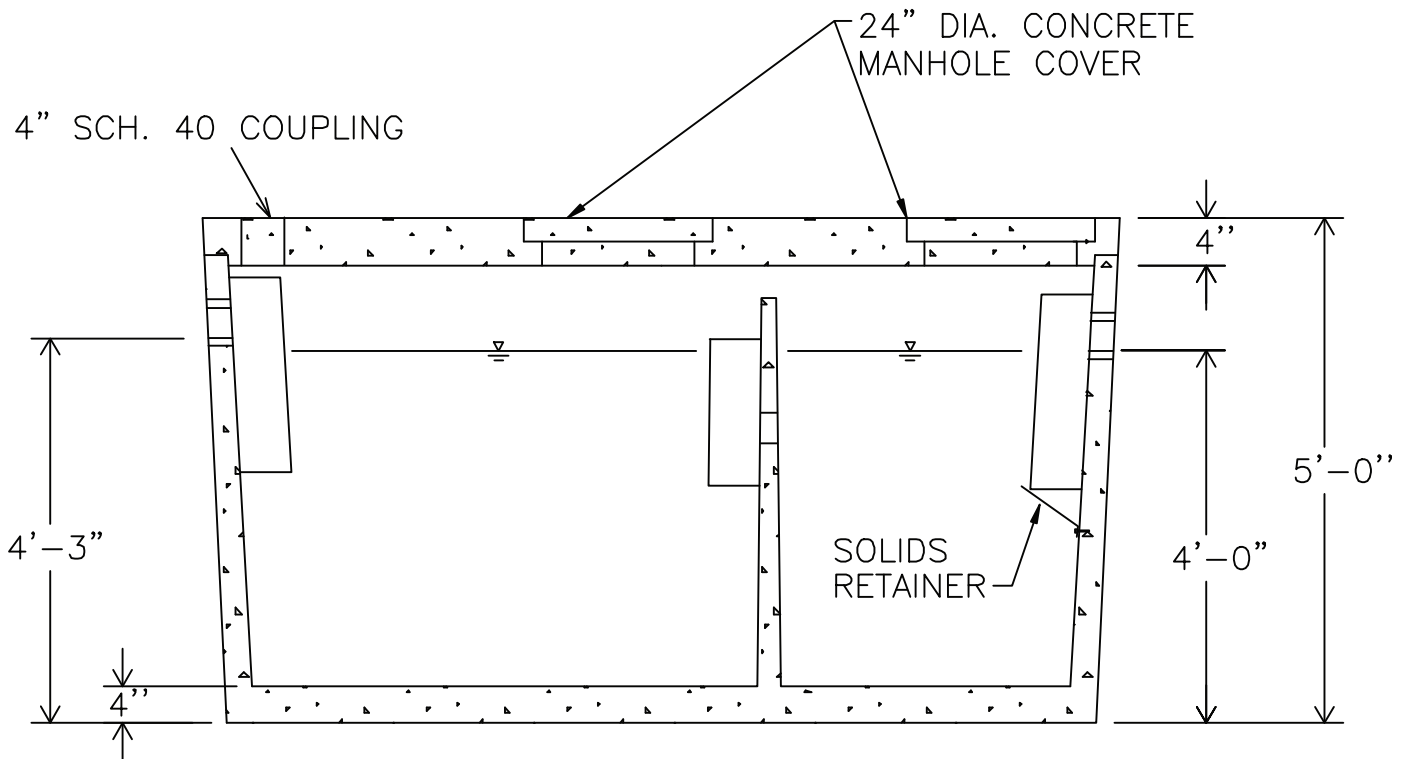

—SECTION—

Non-Traffic Rated, 4 Feet Maximum Cover. Risers, Riser Lids, Pipes & Fittings Sold Separately

**PRECAST
TRANSPORTATION
SOLUTIONS**

322 Bynum Road
Forest Hill, Maryland 21050
Phone: 410-838-3007

**LOW PROFILE
PRECAST 1250 GALLON SEPTIC TANK
TWO COMPARTMENT**

www.precasttransportationsolutions.com